



713 & 723 SLIDING DOOR INSTALLATION MANUAL

VPI QUALITY WINDOWS
3420 E Ferry Ave. Spokane WA. 99202

TABLE OF CONTENTS

Part 1) Preface 3

Part 2) Tools and Materials 3

Part 3) Rough Opening Preparation 4



Part 4) Unit Preparation 5

Part 5) Install and Fasten 5

Part 6) Reinstall the Operable Panel 10

Part 7) Final Adjustment 11

Legend:

	Caution
	Quality
	Safety
RO	Rough Opening
WRB	Water Resistant Barrier
PVC	Polyvinyl Chloride

Always read the Vinyl Window and Door Limited Warranty before purchasing or installing Vinyl Windows and Doors manufactured by VPI Quality Windows. By installing this product, you are acknowledging that this Limited Warranty is part of the terms of the sale. Failure to comply with all VPI Quality Windows and maintenance instructions may void your VPI Quality Windows warranty. See Limited Warranty for complete details at <http://www.vpiwindows.com/>

Part 1) PREFACE

1.1) Installation Instructions for Typical Construction

A) These instructions were developed and tested for use with typical construction in a wall system designed to manage water. **These instructions are not to be used with any other construction method.** Building designs, construction methods, building materials, and site conditions are unique to your project and may require an installation method different from these instructions and additional care. Determining the appropriate installation method is the responsibility of the installer, general contractor, envelope engineer and/or architect. VPI Quality Windows shall not be responsible for site conditions or any variations to these installation instructions.

B)  Please follow the latest version of ASTM E 2112 Standard Practices for Installation.

1.2) Handling and Storage

A) Provide full support under the framework while storing, moving and installing the product.

B)  DO NOT lift the product by the head member only or pull from the jamb members.

C)  DO NOT store in direct sunlight or in containers without adequate ventilation. Allow sufficient spacing between products for ventilation.

D)  DO NOT lean doors more than 10 degrees or in precarious angles. Keep stored in a vertical position if possible.

E)  DO NOT lean more than 7 doors in a stack.

F) Damage caused to the any part of the door or its components from poor storage practices shall not be covered under the limited warranty.

G)  **Due to the size and weight, a minimum of two people are required for installation.**

Part 2) TOOLS AND MATERIALS

2.1) You will need to supply

A) Flat Shims/Spacers

B) Project approved sealants and backer rod

C) #8 X 1" - 2" Pan head corrosion resistant screws or other approved fasteners

2.2) Tools required

A) Tape measure

B) 2,4 and 6 foot Level

C) Square

D) Hammer

E) Flat pry bar

F) Sealant gun

G) Drill

H) #2 & #3 Phillips bit drive

Part 3) ROUGH OPENING PREPARATION

3.1) Confirm the opening is plumb and level.

A) Ensure the sill of the rough opening does not slope toward the interior.

B)  It is critical the sill is level and supported without any interferences that will cause the door frame to twist, bow or tilt.

3.2) Confirm the door will fit the opening.

A) Measure all four sides of the finished rough opening to make sure there is a minimum of ½" clearance in width and height. The finished rough opening includes materials such as WRB, flashing, shims and any other materials that may impede the opening. Measure the width at the top, bottom, and center. Measure the height at the far left side, the far right side, and in the center. The finished RO must be a minimum of ½" wider and taller than the net door frame size.

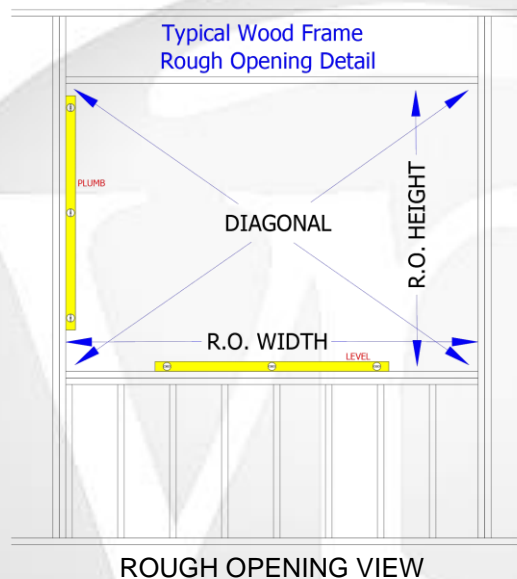

3.3) Sill-Pans



A) Sill-Pans must not interfere with proper sill support and fastening of the door unit or cause distortion to the door sill. It is the responsibility of the installer and/or general contractor to ensure that no distortion, warping or bowing is caused to the unit due to fastening over uneven surfaces. VPI requires all units be installed in a flat vertical plane.

B)  Ensure all waterproofing materials are designed for use with PVC products and installed correctly.

C)  VPI Quality Windows does not endorse or discourage the use of any brand of flashing or sealant materials. Following the flashing manufactures' recommendations, apply flashing to the sills and surrounding wall surface starting with the bottom, sides and top, creating a shingle effect.

Part 4) UNIT PREPARATION

4.1) Remove shipping protection.

- A) Unscrew the 2x4 and inspect the frame and panels for damage.
- B)  If screens or hardware are removed from the door at this time, label them and store them in a protected area.
- C) Remove the operable panel by sliding to the open position. Lift the panel out of the lower track and tilt the bottom of the panel away from the door frame. Then, lower the panel out of the top track.
- D)  DO NOT install damaged units.

Part 5) INSTALL AND FASTEN

5.1)  Two or more people will be required for the following steps.

5.2) Shim thickness and material

- A) Wedge shaped shims are not recommended for use under the sill unless used as part of an engineered sill pan system. Shims must be constructed from high impact non-deteriorating and corrosion resistant material such as PVC or similar plastic.

5.3) Sill shimming

- A) Sill shimming should only be used when the water proofing details require it or the sill is uneven or not level. Fully supported sills without shims are preferred. However, if you choose to use shims, we require the sill to be fully supported with no gaps exceeding two inches and shims within 1/2" from any welded corners.

5.4) Sill Fastening without Nailfin (ripfin)

- A) Sill Fastening without a nailfin should be done using construction adhesive, capable of producing an installation that will support at least 500 lbs per foot when pressurized.

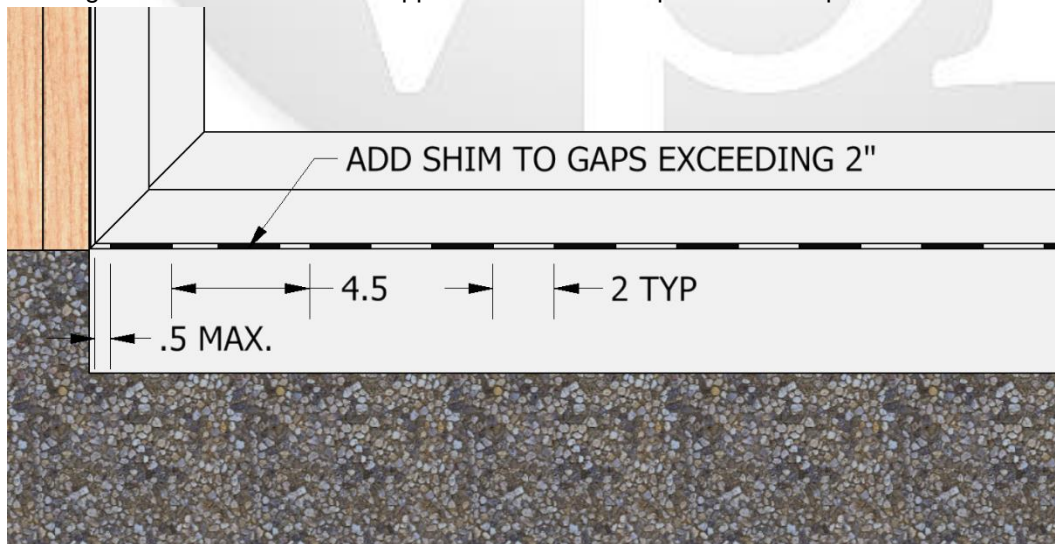

SILL VIEW



5.5) Insert the door

A) Insert the door by placing the sill of the door on the sill of the RO and then tilt the top into position. Center the door between the sides of the opening to allow equal clearance for shimming, insert a couple of screws to hold the door in place while shimming it plumb, level and square.

5.6) Jamb shimming

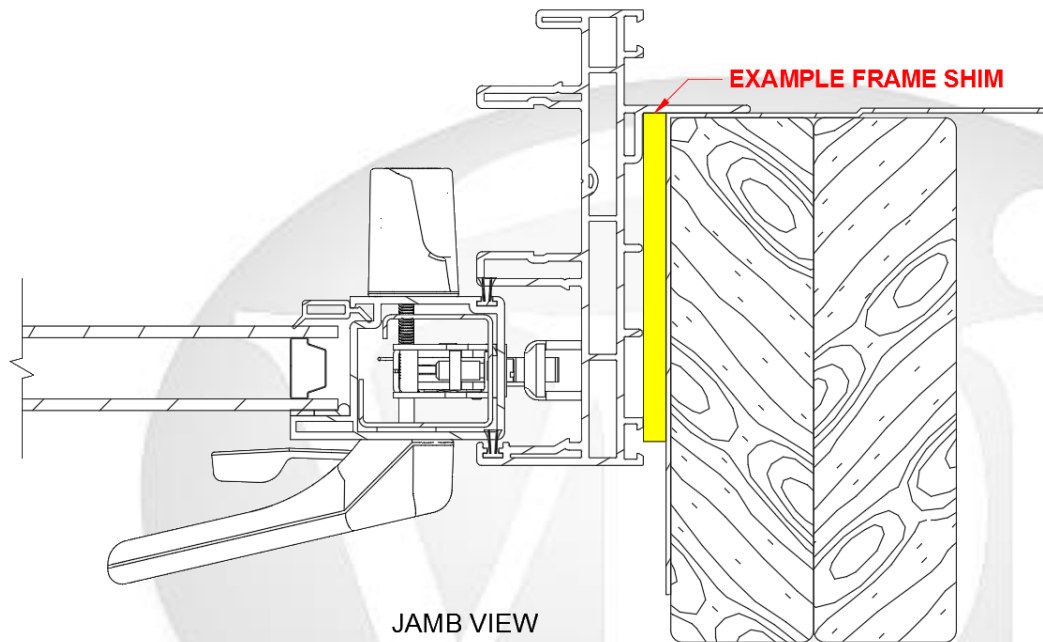
A) Shims are required on both frame jambs and where structural horizontal members intersect the perimeter frame, and at locking hardware points.



- B)  Shims are required at locking hardware points.
- C)  Vinyl doors require shimming and fastening to support the frame from twisting and moving.
- D)  Additional shims may be required for support at the top jamb opposite of the shims. This will help support the hinge jamb by using the head member when installing level. It is the installers' responsibility to address any rough opening framing issues during installation.

5.7)  Do not shim head

A) Shimming the head will not allow for normal building movement and will cause failures that are not warrantable.

5.8) Plumb and square the door

A) Insert shims between the door and rough opening. Keep shims back 1/4" from interior face of door if interior seal is specified. The door must be plumb, level and square to avoid having unnecessary adjustments to the sash panel.

- B)  Shims must be verified before fastening.

5.9) Frame Squaring

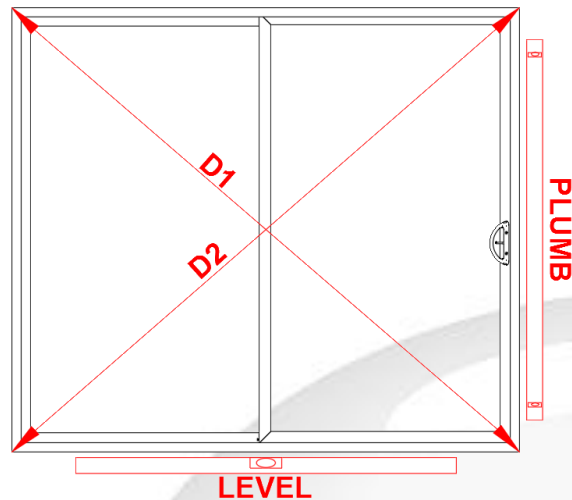

A) **Frame Squaring** is essential. To do this properly one must first take corner to corner dimensions (D1 & D2) then determine if both dimensions are within the allowed 1/8" of tolerance. If not then split the difference and that is the overall adjustment that needs to be made.

B) **Level & Plumb** Use a level to check the sill and jamb to determine if the frame is level and plumb.

FRAME SQUARING VIEW

5.10) Fasten the door to the opening

A) Head must be fastened, beginning 4"-8" from welded corners, then every 12" on center using fender washers lapped over nailing flange a minimum of 3/8", leaving a minimum of 3/8" gap between shaft of fastener and edge of nailing flange.

B) Fastener size is #8 and must penetrate structural framing a minimum of 1" in depth and must be constructed of corrosion resistant material such as stainless steel, galvanized or other coating.

C) Place fasteners in every hole of the nail flange along jamb and sill beginning 4"-8" from welded corners. (See fastening detail below)

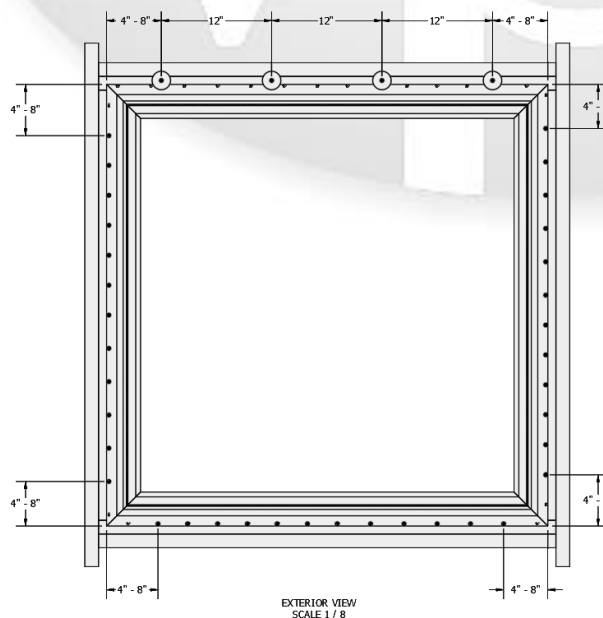

D) For Patio Doors with nailing-fin removed at the sill, the sill attachment method using construction adhesive is shown below:

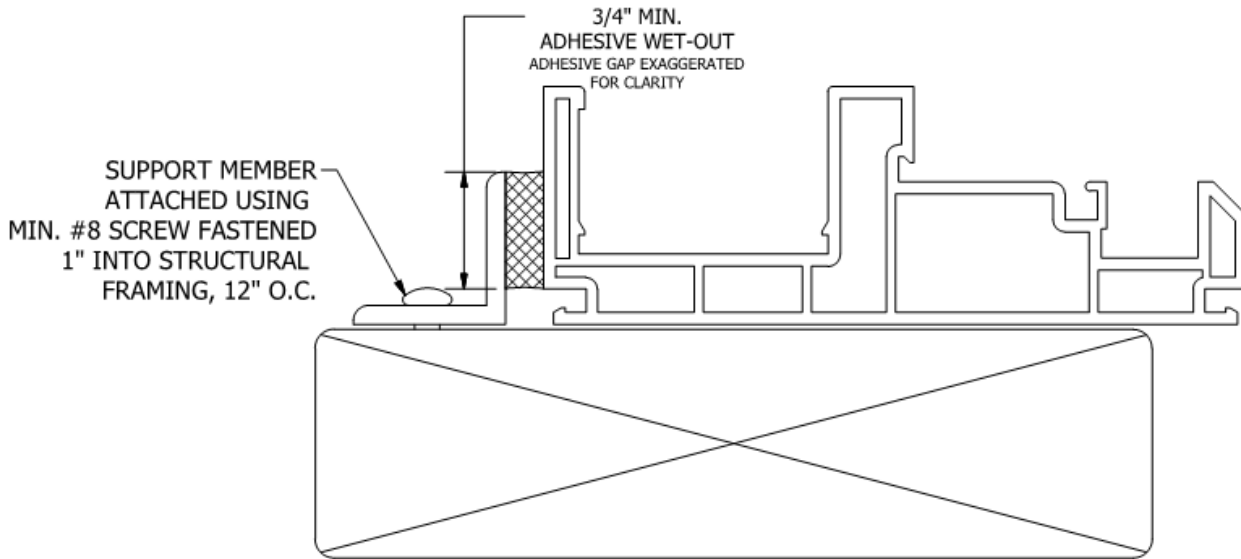

- MINIMUM ADHESIVE TENSILE STRENGTH - 55 PSI
- ADHESIVE CONTACT MUST BE DIRECTLY BETWEEN SUPPORT MEMBER AND VINYL FRAME
- 723 ENDURANCE PATIO DOOR SHOW, 713 BELLEVUE PATIO DOOR INSTALLED IN SAME MANNER

E) Shims are required to prevent twisting of the frame.

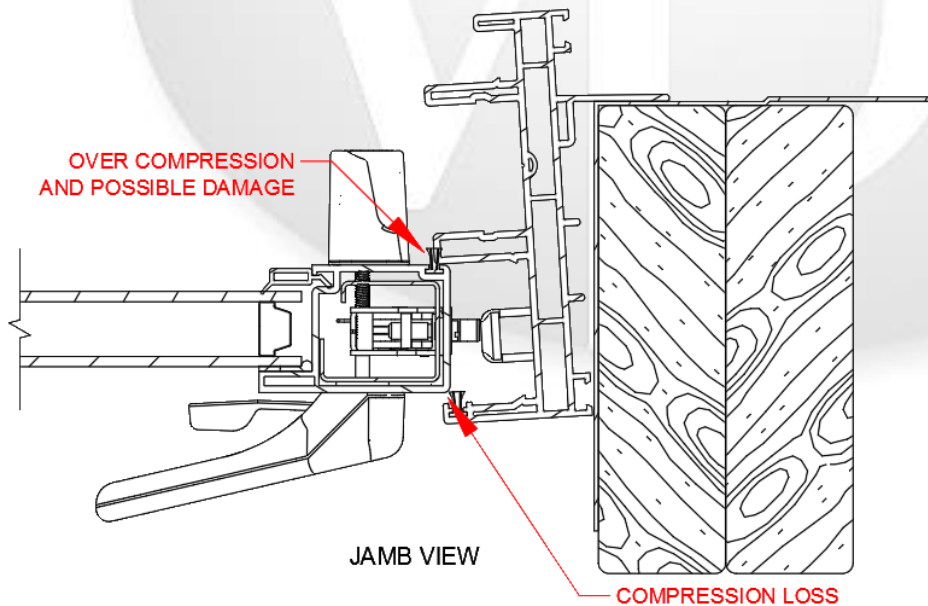

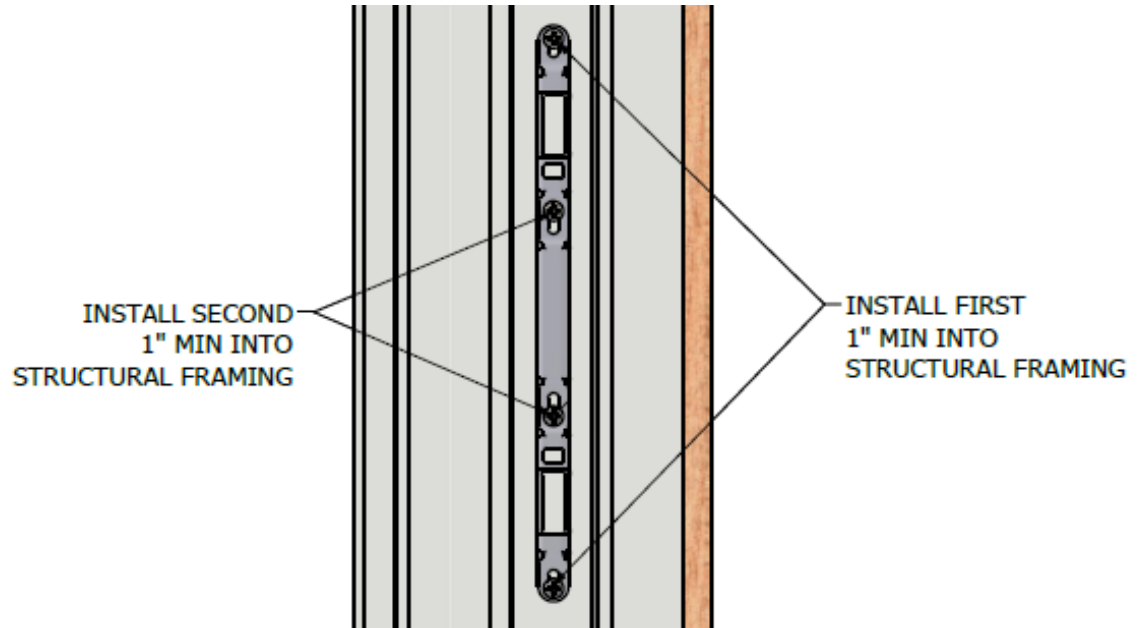

F) The door will ship with two screws installed in the strike. They are intended to hold the strike in the correct location relative to the locking mechanism during shipping. The strike must be fastened into structural framing a minimum of 1" for full forced entry strength.

- I) Install screws in the top and bottom holes first
- II) Remove the screws that were shipped with the door
- III) Install screws that penetrate 1" minimum into structural framing

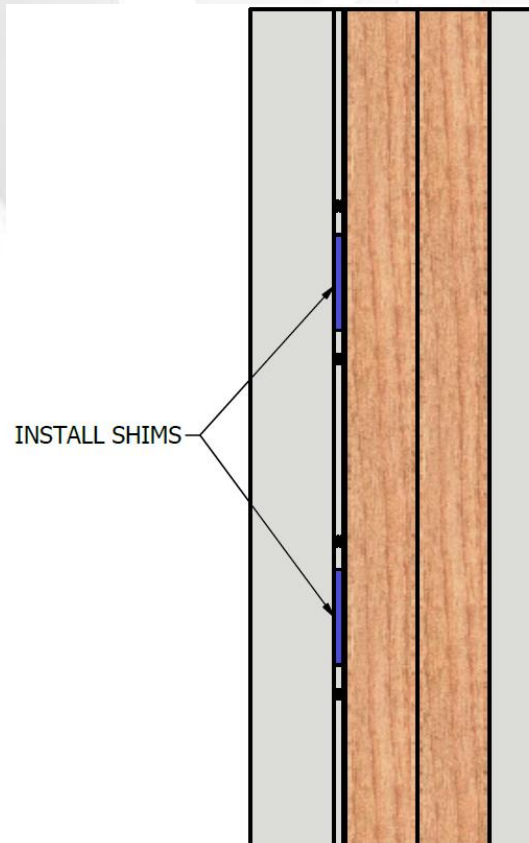

- IV) Shims are required at the strike to ensure the frame is not deformed by overtightening screws.



- G)  **All fasteners** must be constructed from or coated with corrosion resistant material such as, but not limited to stainless or galvanized steel. Screws must penetrate a minimum of 1" into structural framing.

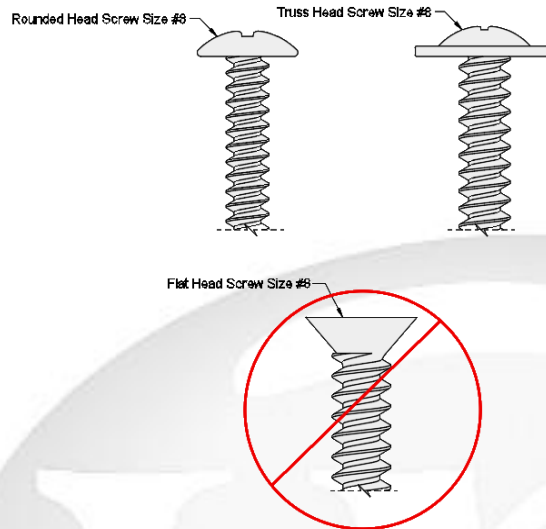

- H)  **DO NOT** over tighten as this may distort or twist the frame.

Part 6) REINSTALL THE OPERABLE PANEL

6.1) Installing Door Panel

- A)  Inspect the door panel for damages to the vinyl, weatherstrip and glass.
- B) Insert the door panel from the interior of the building, tilt the top of the panel toward the door frame and lift up into the top track. Move the bottom of the panel towards the door frame until it is vertical. Gently set the panel down into the bottom track.

Part 7) FINAL ADJUSTMENT

7.1) Adjust the rollers so the operable panel rolls freely and is parallel to the fixed interlock. Remove the weight from the roller during adjustment. Rotate the roller adjustment screws clockwise to raise the panel or counterclockwise to lower the panel. The screws are located at the bottom of the operable panel on each jamb. Once plumb, adjust the operable panel to the proper height to attain even coverage of the weatherstrip at both top and bottom as viewed from the exterior.

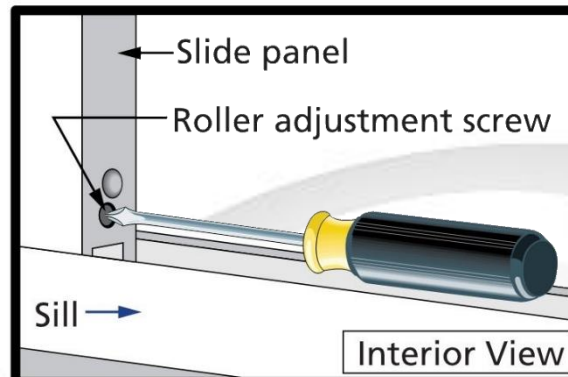

7.2) Verify the reveal is consistent on the operable panel to the frame. (See Below)

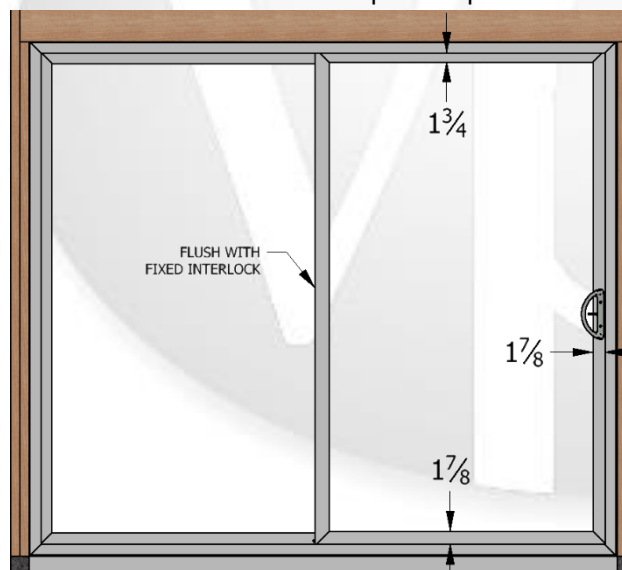

REVEAL VIEW

- A) It is the responsibility of the installer to verify the door operates and locks correctly; adjustments are required by the installation company to finalize the install. Follow ASTM E 2112 Standard Practices for Installation. Please contact VPI for any assistance or training with our product @ 1-800-634-1478

